

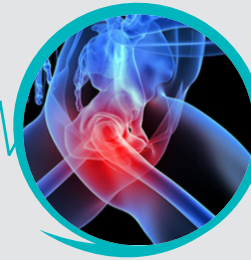

ORTHOPEDIC

SURGICAL DRAPES AND KIT



DESIRE TO CHANGE From Reusable To Disposable

*Disposable drapes avoid repeated steps.
Save resource and offers safety.*



Washing & Cleaning



**Drying ,
Folding and Packing**



Sterilization



**LINT is Source of Infection
And Allergy**



**Blood Stains, Chemical
Stain & tears may lead to
discomfort**



ADVANTAGES OF DISPOSABLE DRAPES OVER REUSABLE LINEN

Disposable drapes avoid repeated Washing, Cleaning, Drying, Folding, Packing & Sterilization Step.

Disposable drape saves resources Water, Power, Time & Manpower.

Disposable drape offers High Barrier to Blood and Body Fluids.

Disposable drape are cost effective.

Disposable drapes are Lint free, Tear free - Hence Safer and Comfortable.

Regd. Office : RE-17/10, Raghunathpur Housing Estate
Raghunathpur, Kolkata - 700 059, WB, INDIA
Ph. - +91 9831 2322 47
Outlet : Shop No.-07, Block-A, VIP Enclave
VIP Road, Kolkata - 700 059
Ph. - + 91 8017 0527 00

A COMPARATIVE STUDY

COMPONENT	SAFE WEAR	CHEAP ALTERNATIVE	SAFE WEAR ADVANTAGE
1. Incise film	High quality PU film	LD/PE films	<p><u>SAFE WEAR PU incise film is</u></p> <ul style="list-style-type: none"> • Breathable: Allows air and moisture to transfer through the film keeping the covered area and comfortable. LD and PE film are non-breathable • Conformable : Unlike LD/PE films, our incise film conforms easily to the shape of body contours ad creates a soft layer like a second skin allowing for cleaner and more precise incisions. Bacteria impenetrable: Creates a complete sterile field around the surgical site by creating a complete barrier to bacteria and other micro-organisms • Low Glare: Unlike LD/PE films which create a glare through reflection of light, our incise film is extremely low glare in order to provide the surgeon with a clear, unobstructed view of the incise area during surgery
2. Adhesive	Skin friendly medical-grade adhesive	Industrial adhesive	<ul style="list-style-type: none"> • The adhesive used by fine wear is carefully quality-controlled tested for cytotoxicity to ensure zero skin-irritation or skin allergies due to application • The SAFE WEAR adhesives have the right balance of adhesive strength and peel strength to ensure proper adhesion during surgery and easy, pain-free peel-off after surgery • Cheaper alternatives use normal industrial grade adhesive which do not care for the above properties and can cause skin problems
3. Fabric	High quality SMS/ Sontara	Spunbond	<ul style="list-style-type: none"> • SAFE WEAR uses only high quality SMS material, Which is a trilaminate fabric having 3 layers, while spunbond is a single layer cheap fabric normally used for making non-woven shopping bags. • The middle layer of meltblown ensures over 98% bacterial filtration efficiency to minimize the chances of cross infection. spunbond, on the other hand, has almost zero bacterial filtration properties. • Our SMS fabric has a high hydrostatic head to create a strong a liquidpenetration barrier, thus keeping the patient dry and comfortable. The hydrostatic head of spunbond is much lower by comparison. • Our SMS fabric is also soft on the skin, unlike spunbond which has a much rougher feel.
4. Lining Film	Hygiene film	LD film	<ul style="list-style-type: none"> • SAFE WEAR hygiene film is made of high quality virgin PE material, which gives it very good drapability and comfort compared to LD. • Unlike some films that contain fillers, SAFE WEAR hygiene film is completely skin friendly. • LD films make crackling sounds when moved or crumpled, which can be very distracting during a surgical procedure. fine wear hygiene films provide for extremely quiet handling, allowing the healthcare staff to concentrate other surgery without disturbance during the producer.

ARTHROSCOPY KIT

The **SAFE WEAR'S** Arthroscopy pack comes in two designs, that is knee Arthroscopy Pack and shoulder Arthroscopy Pack. Knee / Shoulder Arthroscopy pack comes as **Multi-part pack**, that is **surgeon gown pack, Trolley Pack & patient Pack**.

Sl.No	Description	Quantity
Surgeon Gown Pack		
1	Surgeon Gown - Reinforced	4 nos.
2	Hand Towel	8 nos.
Trolley Pack		
4	Implant Trolley Sheet wit ABS	1 no.
6	Instrument Trolley Sheet with ABS	1 no.
7	Small Trolley Sheet	2 nos.
Patient Pack		
Safe -1	Large Drape	2 nos.
8	Stockinet	1 no.
9	O.P. tape	1 no.
D-1,D-3	Knee-O-Drape with Screen Sheet (in TKR Pack)	1 no.
10	Cautery Bag	1 no.
11	Suction Device Bag	1 no.

Sl.No	Description	Quantity
Surgeon Gown Pack		
Safe-1	Large Drape	2 nos.
8	Stockinet	1 no.
9	O.P Tape	1 no.
D-5	Split - u - Drape	1 no.
D-6	Shoulder Arthroscopy Drape	1 no.
10	Cautery Bag	1 no.
11	Suction Device Bag	1 no.

TKR / THR - SURGEON GOWN PACK

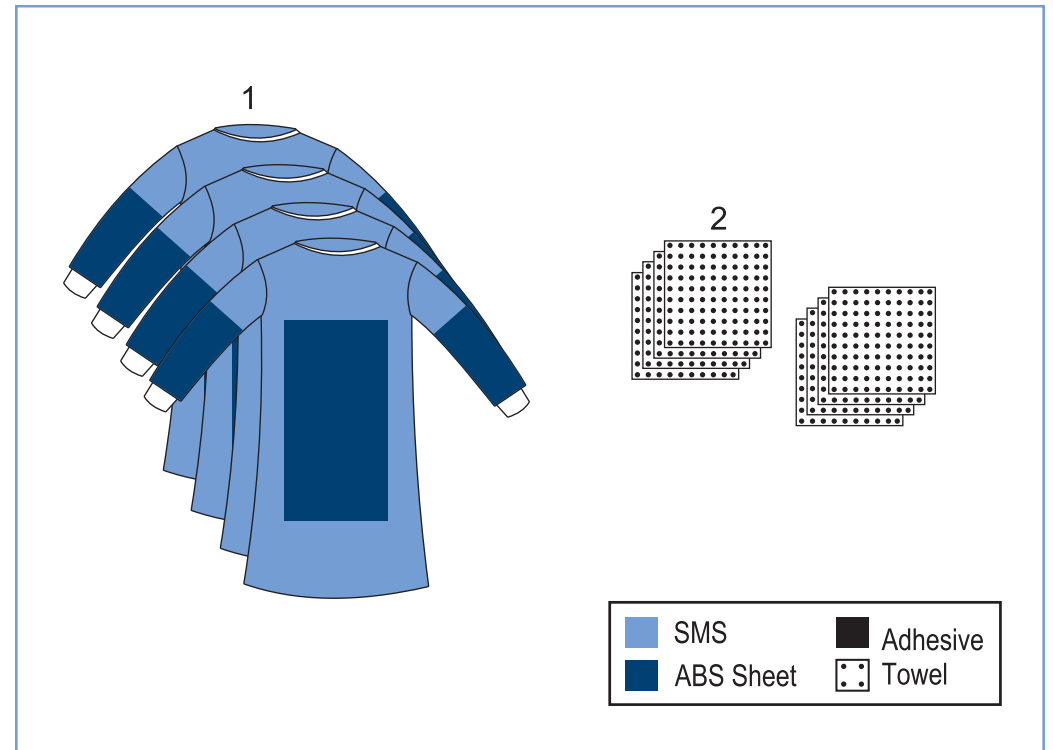

Benefits of SAFE WEAR'S Arthroscopy Kit:

- ▶ **SAFE WEAR'S** Surgeon gowns are unique and come with **reinforced layer over body & sleeve** (from elbow to cuff).
- ▶ Arthroscopy Drape comes with **2.5 inch (for knee) / 2 inch (for shoulder)** conformable Circular fenestration - **Ensure comfortable draping.**
- ▶ Arthroscopy drape comes with **wide collecting pouch & suction port** - **Avoid spill out & offers sufficient fenestration area.**
- ▶ Cautery bag comes with **distant 3 compartments.**
- ▶ **Standard labeling and arrow signs (→)** on drape for unfolding - **Ensures faster and comfortable draping.**

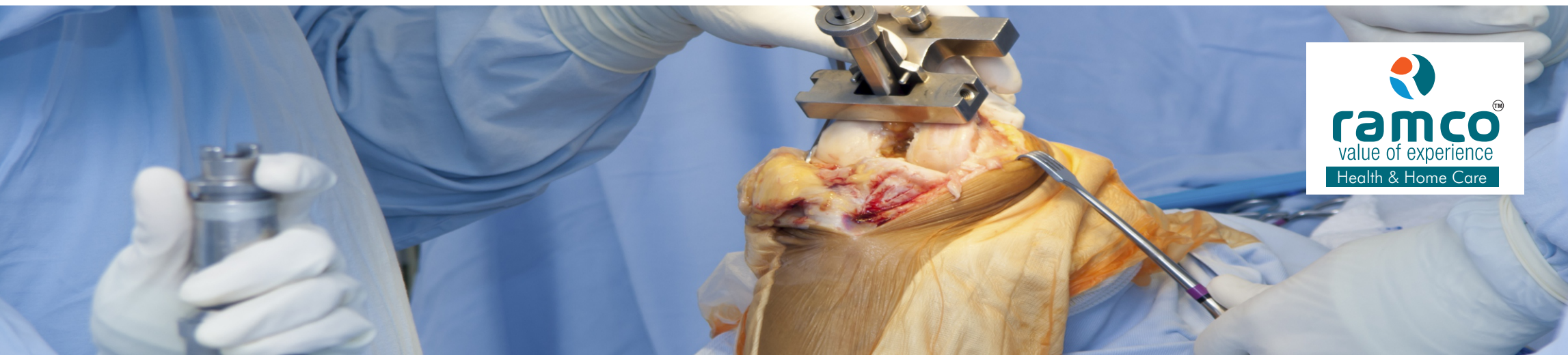

KNEE ARTHROCOPY & SHOULDER ARTHROSCOPY - TROLLEY PACK

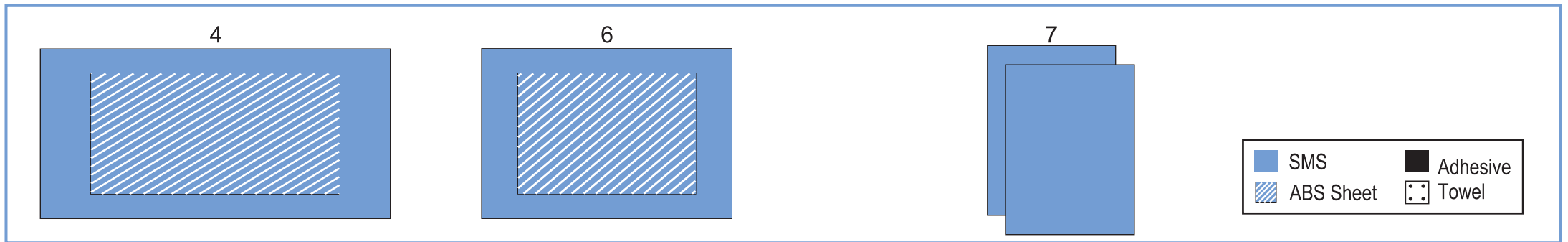

KNEE ARTHROCOPY & SHOULDER ARTHROSCOPY - PATIENT PACK

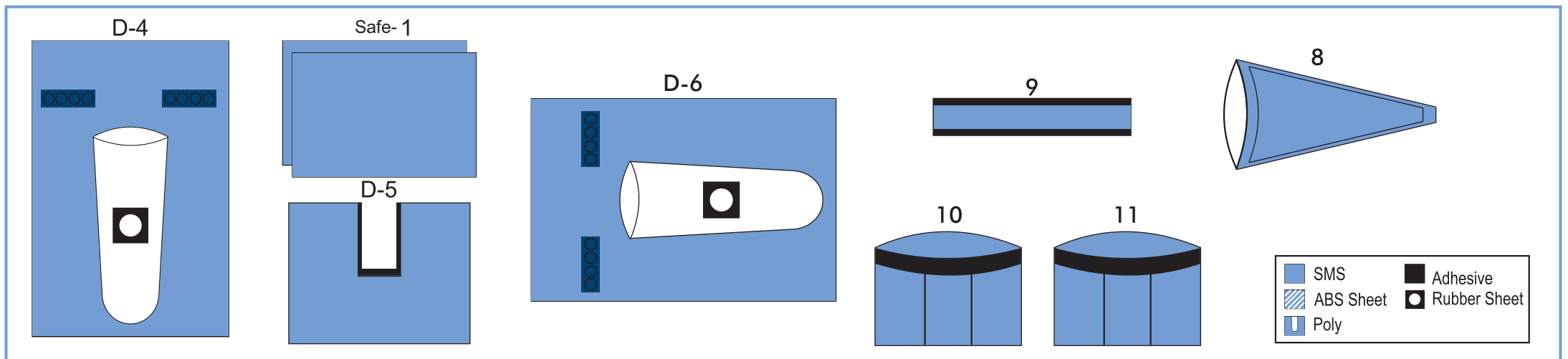

T.K.R./T.H.R. PACK

The **SAFE WEAR'S** TKR/THR Pack comes as **Multi - part pack**, That is **Surgeon gown pack, trolley pack & patient Pack**.

Sl.No	Description	Quantity
Surgeon Gown Pack		
1	Surgeon Gown - Reinforced	4 nos.
2	Hand Towel	8 nos.
Trolley Pack		
4	Implant Trolley Sheet wit ABS	1 no.
6	Instrument Trolley Sheet with ABS	1 no.
7	Small Trolley Sheet	2 nos.
Patient Pack		
Safe - 1	Large Drape	2 nos.
8	Stockinet	1 no.
9	O.P. tape	1 no.
D-1	Knee-O-Drape with Screen Sheet (in TKR Pack)	1 no.
D-2	Hip-U-Drape(in THR Pack)	1 no.
D-3	Screen Sheet (in THR Pack)	1 no.
10	Cautery Bag	1 no.
11	Suction Device Bag	1 no.

BENEFITS OF SAFE WEAR'S T.K.R. KIT

- ▶ **SAFE WEAR'S** Surgeon gowns are unique and come with **reinforced layer over body & sleeve** (from elbow to cuff).
- ▶ **Knee-o-drape** with **2 inch** conformable circular fenestration.
- ▶ Single Knee-o-drape **covers patient & screen area**.
- ▶ **No confusion** while draping knee-o-drape, thereby ensuring 100% sterility.
- ▶ Cautery bag comes with **distant 3 compartments**.
- ▶ **Standard labeling and arrow signs (→)** on drape for unfolding -**Ensures faster and comfortable draping**.

T.K.R./T.H.R. SURGEON PACK

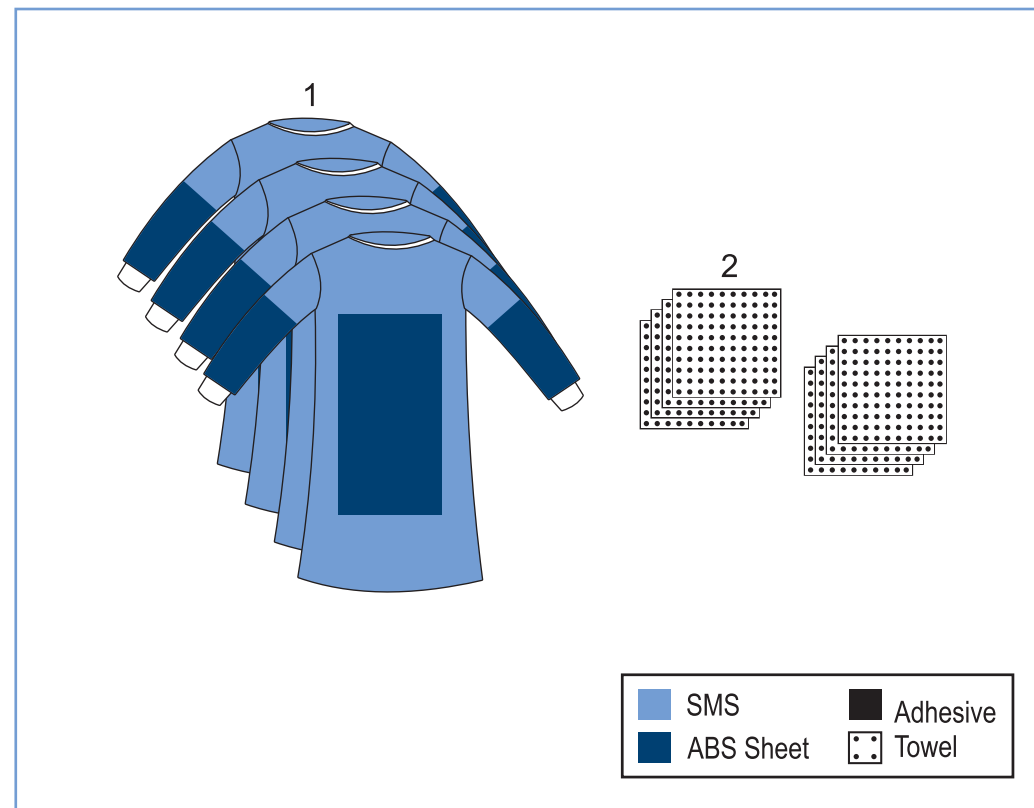

BENEFITS OF SAFE WEAR'S T.K.R. KIT

- ▶ **SAFE WEAR'S** Surgeon gowns are unique and come with **reinforced layer over body & sleeve** (from elbow to cuff).
- ▶ **Hip-U-drape** comes with conformable U split - there by very convenient.
- ▶ **No confusion** while draping Hip-U-drape, thereby ensuring 100% sterility.
- ▶ Cautery bag comes with **distant 3 compartments**.
- ▶ **Standard labeling and arrow signs (→)** on drape for unfolding -**Ensures faster and comfortable draping**.

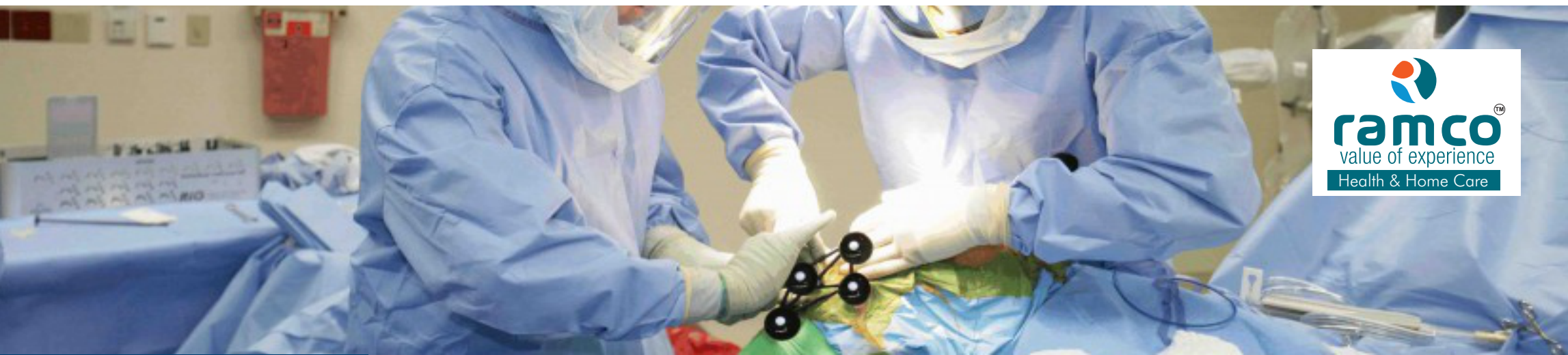

TKR / THR - TROLLEY PACK

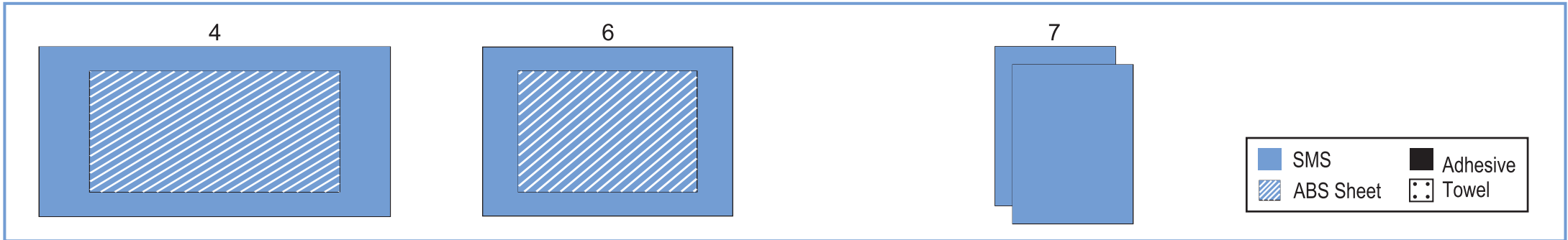

TKR / THR - PATIENT PACK

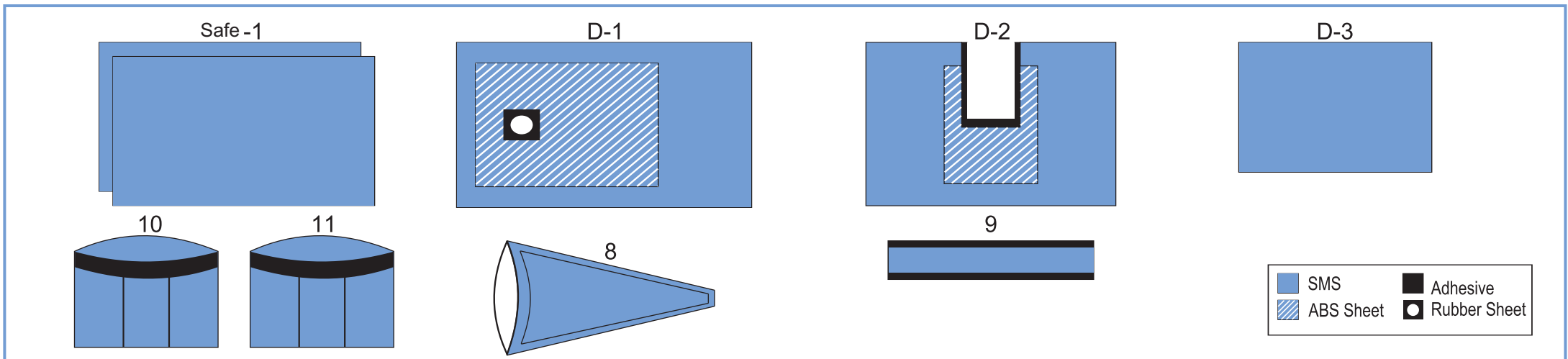

LAMINO SPINAL KIT

The FINE WEAR'S Lamino Spinal KIT comes as Multi - part pack, That is Surgeon gown pack, trolley pack & patient Pack.

Sl.No	Description	Quantity
Surgeon Gown Pack		
1	Surgeon Gown - Reinforced	4 nos.
2	Hand Towel	8 nos.
Trolley Pack		
4	Implant Trolley Sheet wit ABS	1 no.
6	Instrument Trolley Sheet with ABS	1 no.
7	Small Trolley Sheet	1 no.
Safe-5	Mayo Trolley Cover with ABS	1 no.
Safe-6	C-arm Cover	1 Pair.
Patient Pack		
Safe-1	Large Drape	2 nos.
Safe-4	Side Drape	2 nos.
D-7	Lamino Spinal Drape	1 no.
10	Cautery Bag	1 no.
11	Suction Device Bag	1 no.

Benefits of SAFE WEAR'S Lamino Spinal Kit:

- ▶ **SAFE WEAR'S** Surgeon gowns are unique and come with **reinforced layer over body & sleeve** (from elbow to cuff).
- ▶ **SAFE WEAR'S** Lamino Spinal drape comes with 15x35cm Fenestration area - offers Sufficient fenestration for spinal surgery.
- ▶ Sufficient fenestration with quality incise - Ensures easier access & minimal Invasive.
- ▶ **No confusion** while draping knee-o-drape, thereby ensuring 100% sterility.
- ▶ Cautery bag comes with **distant 3 compartments**.
- ▶ **Standard labeling and arrow signs (→)** on drape for unfolding - **Ensures faster and comfortable draping.**

LAMINO SPINAL - PATIENT PACK

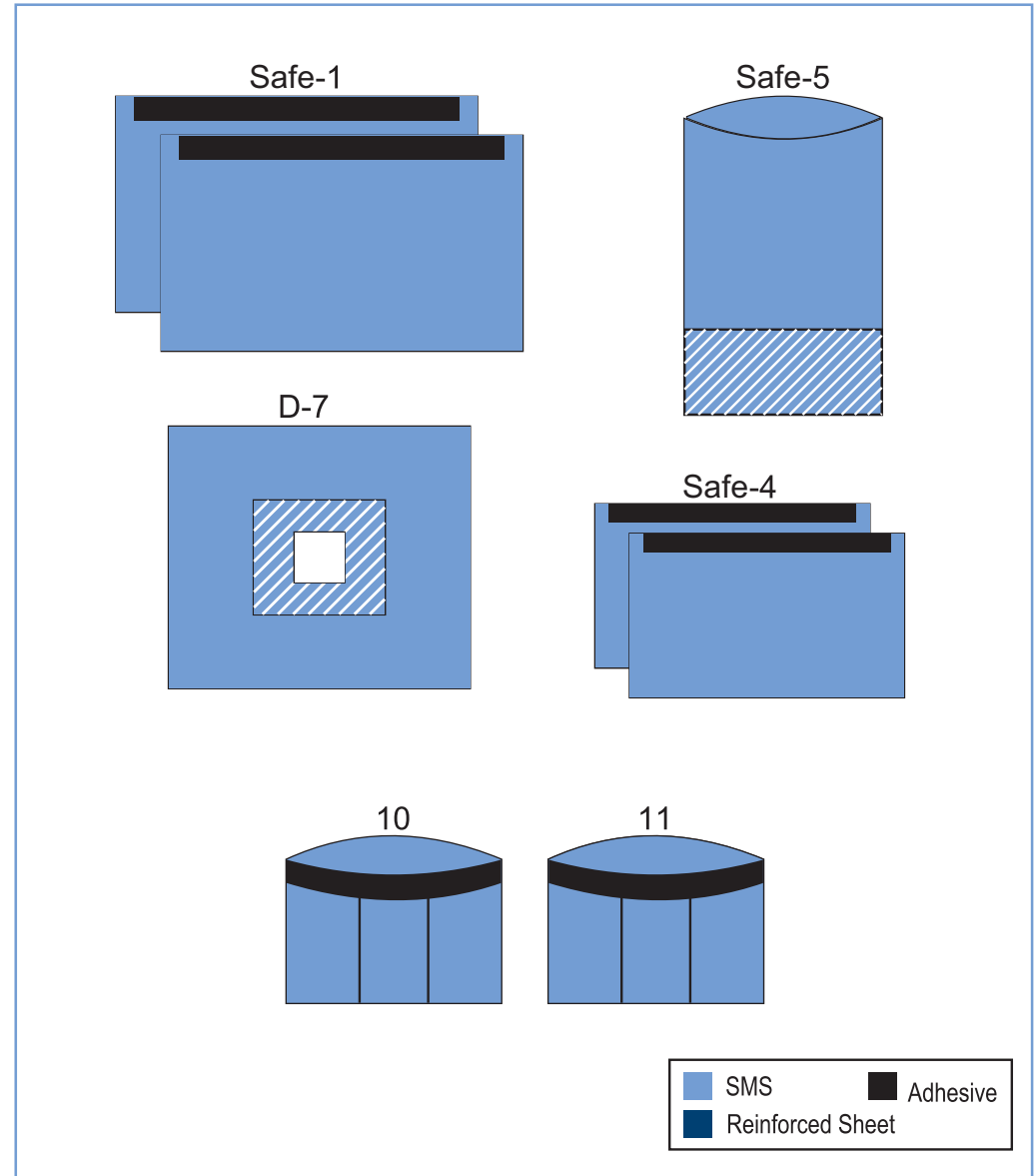

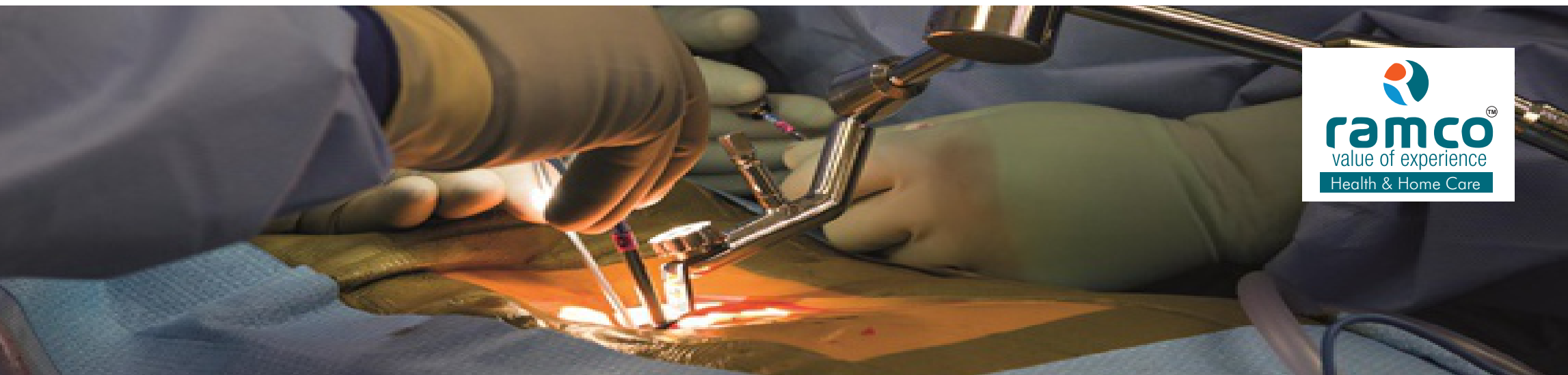

ORTHOPEDIC ACCESSORIES

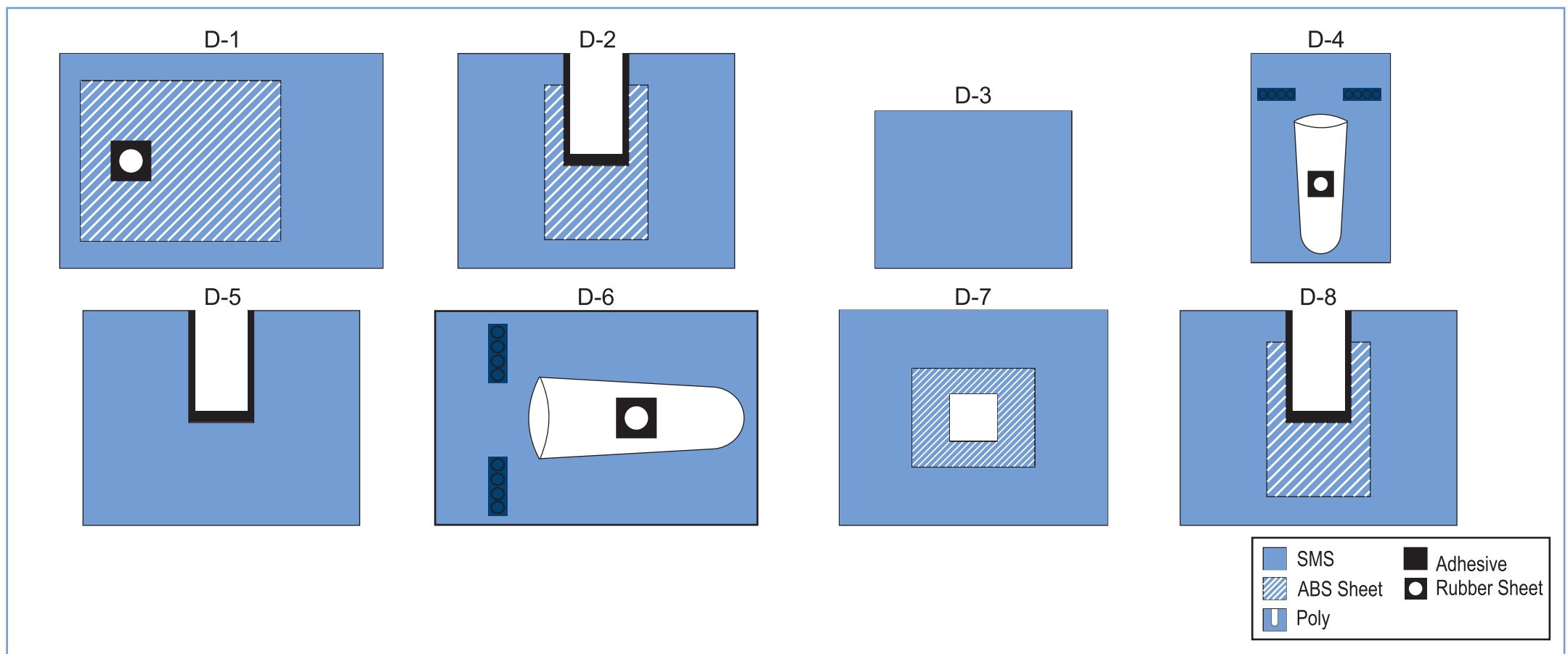

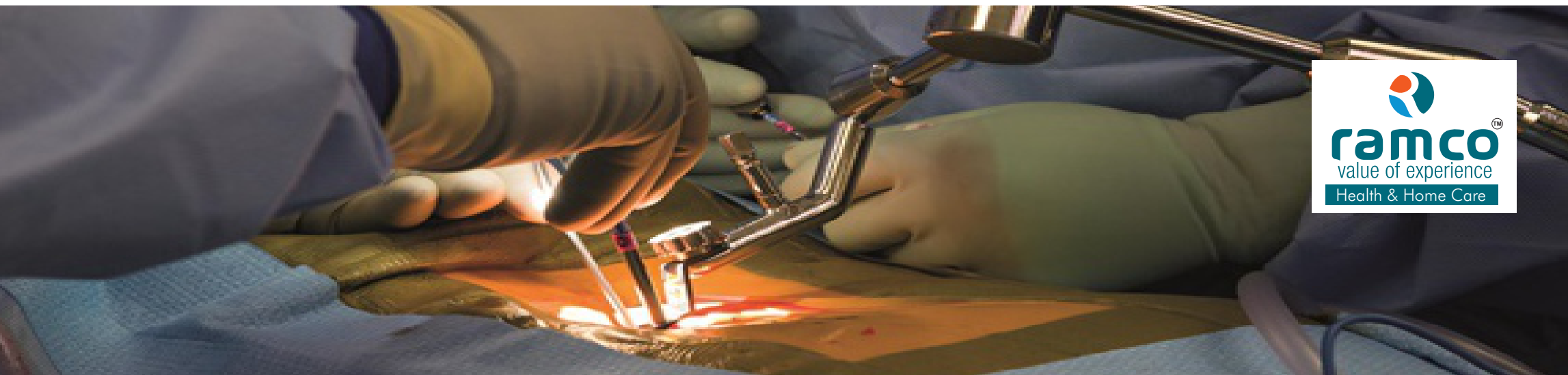

ORTHOPEDIC ACCESSORIES

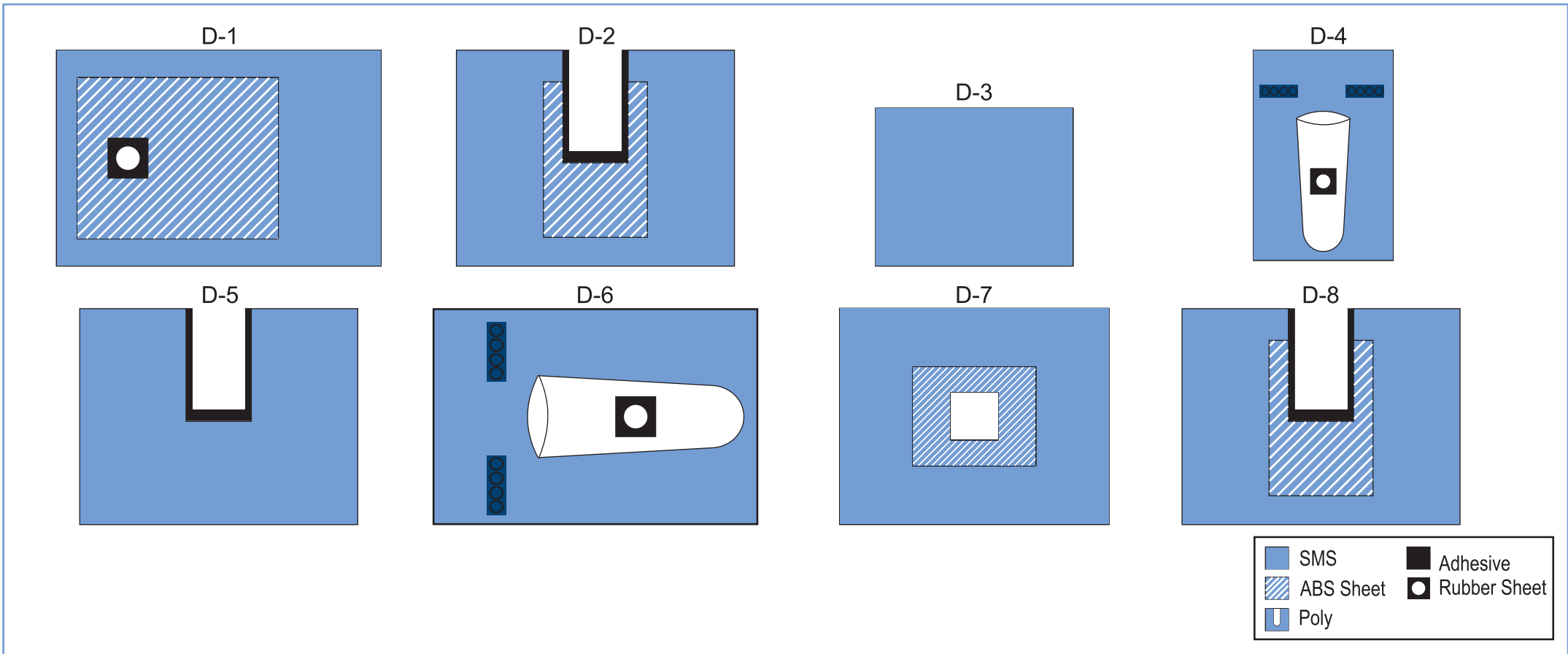

ORTHO ACCESSORIES

FINE WEAR'S orthopedic accessories are available in individual packs.

Sl.No	Description
1	Reinforced Gown
2	Hand Towel
3	Large Trolley sheet with ABS
4	Implant Trolley sheet with ABS
5	Medium Trolley sheet with ABS
6	Instrument Trolley sheet with ABS
7	Small Trolley sheet
8	Stockintte
9	O.P. Tape
10	Cautery Bag
11	Suction Device Bag

Sl.No	Description
D-1	Knee O drape
D-2	Hip U Drape
D-3	Screen Sheet
D-4	Knee Arthroscopy Drape
D-5	Split - U - Drape
D-6	Shoulder Arthroscopy Drape
D-7	Lamino Spinal Drape
D-8	General U drape
Safe-1	Large drape
Safe-2	Medium drape
Safe-3	Small drape
Safe-4	Side drape
Safe-5	Mayo trolley Cover with ABS
Safe-6	C - Arm Cover



CHANGE IS DESIRE FOR EXCELLENCE

- Disposable drapes save resource and avoid time consuming processes for the hospital.
- Our medical fabric meets AAMI PB 70 (American) & EN 13795 (European) Standards.
- Ensures Faster & comfortable surgical draping.
- Committed to deliver quality products at affordable prices.
- Trusted product partner to more than 200 hospital across India.
- Prompt delivery.
- Technical training to OT & CCSD personnel.



Regd. Office : RE-17/10, Raghunathpur Housing Estate
Raghunathpur, Kolkata - 700 059, WB, INDIA, Ph. - +91 9831 2322 47

Outlet : Shop No.-07, Block-A, VIP Enclave
VIP Road, Kolkata - 700 059, Ph. - + 91 9007038020

www.ramcoindia.co.in
e-mail : ramcocal@gmail.com